



Schwinn® Technical Manual



Important Safety Information

The following pages are intended to educate service technicians on the basic maintenance and service actions for the SCHWINN Indoor Cycling bikes. By following the enclosed instructions and maintenance schedule, you will extend the life of your bikes and help ensure the equipment will withstand hours of use in your home/facility.

Before working on this equipment, pay attention to the following warnings:

- Read and understand the complete Owner's Manual.
- Keep Owner's Manual for future reference.
- Read and understand all warnings on this machine. If at any time the Warning stickers become loose, unreadable or dislodged, contact Customer Service for replacement stickers.
- Keep children away from this machine. Monitor them closely when near the machine. Parts that move and appear dangerous to adults can appear safe to children.
- Consult a physician before you start an exercise program. Stop exercising if you feel pain or tightness in your chest, become short of breath, or feel faint. Contact your doctor before you use the machine again. Use the values calculated or measured by the machine's computer for reference purposes only.
- Before each use, examine this machine for loose parts or signs of wear. Do not use if found in this condition. Monitor the Seat, Pedals, and Crank Arms closely. Contact Customer Service for repair information.
- Maximum user weight limit: 350lbs. (159kgs). Do not use if you are over this weight.
- Do not wear loose clothing or jewelry. This machine contains moving parts.
- Set up and operate this machine on a solid, level, horizontal surface.
- Do not step off the machine until the Pedals have fully stopped. Use the Resistance Adjustment Knob to slow the Pedals to a controlled stop before you step off the machine.
- Do not operate this machine outdoors or in moist or wet locations.
- Keep at least 19.7"(0.5m) on each side of the machine clear. This is the recommended safe distance for access and passage around and emergency dismounts from the machine. Keep third parties out of this space when machine is in use.
- Do not over exert yourself during exercise. Operate the machine in the manner described in this manual.
- When the machine is put in a studio or club environment, it can only be used in areas where access and control of the machine is managed by approved staff. The degree of management depends on the user's ability to recognize and prevent danger to third parties during the exercise movement.



Index

Warranty Information

Schwinn Product Line Details

- **AC Performance Plus**
 - Chain
 - Carbon Blue
- **AC Sport**
 - Chain
 - Carbon Blue
- **IC Pro**
- **IC Pro 20**

Tool and Recommended Supplies List

Preventative Maintenance

Adjustments

- **Belt / Chain Tensioning**
- **Belt / Chain Removal / Replacement**
- **Pedal Adjustment**
- **Leveling Feet**
- **Crank Arms / Bottom Bracket**
- **Handlebar & Seat Post Lubrication**
- **Resistance Mechanism Adjustments**
- **Brake Rod & Knob Replacement**
- **Adjusting Smart Release**
- **Smart Release Removal / Replacement**
- **Bottom Bracket Removal / Replacement**
- **Flywheel Bearing Removal / Replacement**



Warranty Information

PRODUCT WARRANTY DOES NOT COVER:

1. Any component on original equipment, which carries a separate consumer warranty provided by the component part's supplier/manufacturer.
2. Normal wear and tear (please see the definition of "Wear Items" below).
3. Any damage, failure or loss caused by accident, misuse, neglect, abuse, improper assembly, improper maintenance, use of an improper or unauthorized replacement part, or failure to follow instructions or warnings in Owner's Manual.
4. Use of products in a manner for which they were not designed or intended to be used.
5. Improper use of any product, unless otherwise noted in the Owner's Manual.

- **Wear Items** are parts/components that might need to be replaced due to normal use during the life of the product. User-life for wear items will vary depending on uncontrolled parameters (i.e., placement environment, frequency of use, type of user, scheduled maintenance, etc.). Wear items vary for each product but will include, and not be limited to: computer overlays, grips, belts, drive-train components, brake pads, pedals, pedal straps, toe clips, and upholstery, etc.

- A **defect in materials and/or workmanship is best described as** a problem related to structural failure, weakness, or deficiency in manufacturing quality. These are factors controlled through the product development, production and quality control process. A true defect in materials and/or workmanship will usually be recognized within a short period of initial product use.



AC Performance Plus



Chain Drive



Carbon Blue Belt Drive

Technical Specs		
50" L x 21" W x 51" H	Product Dimensions	50" L x 21" W x 51" H
112 lbs. (51 kg)	Product Weight	112 lbs. (51 kg)
350 lbs. (159 kg)	Max User Weight	350 lbs. (159 kg)
Aluminum	Frame Finish	Aluminum
Pearl White	Frame Color	Pearl White
Aluminum	Seat Slider, Handlebars and Hardware Materials	Aluminum
Chain drive using forged steel crank and ISIS oversized bottom bracket	Drive System	Belt drive using Carbon Blue™ technology
Typically 4'11" to 6'8" (150 to 203 cm) tall	User Compatible Size Range	Typically 4'11" to 6'8" (150 to 203 cm) tall
Yes	MPower™ Console Compatible	Yes
Yes (Double Link Standard)	Triple Link Pedal Compatible	Yes (Double Link Standard)
U.S. Commercial Warranty		
10 yrs. (5 yrs. corrosion)	Frame	10 yrs. (5 yrs. corrosion)
2 yrs. (drive mechanism, braking system, cranks)	Mechanical parts	2 yrs. (drive mechanism, braking system, cranks)
1 year	Labor	1 year
6 mos. (saddle, pedals)	Wear Items	6 mos. (saddle, pedals)
Note Warranty terms are for the U.S. only and vary by region. Contact the distributor in your country and region.		



AC Sport



Chain Drive



Carbon Blue Belt Drive

Technical Specs		
48" L x 20" W x 48" H	Product Dimensions	48" L x 20" W x 48" H
126 lbs. (57 kg)	Product Weight	126 lbs. (57 kg)
350 lbs. (159 kg)	Max User Weight	350 lbs. (159 kg)
Zinc-plated Steel Frame Construction	Frame Finish	Zinc-plated Steel Frame Construction
Deep Silver	Frame Color	Deep Silver
Stainless steel plated slider and posts	Seat Slider, Handlebars and Hardware Materials	Stainless steel plated slider and posts
Chain drive using forged steel crank and ISIS oversized bottom bracket	Drive System	Belt drive using Carbon Blue™ technology
No	Smart Release	No
Typically 4'11" to 6'8" (150 to 203 cm) tall	User Compatible Size Range	Typically 4'11" to 6'8" (150 to 203 cm) tall
Yes	MPower™ Console Compatible	Yes
Yes (Double Link Standard)	Triple Link Pedal Compatible	Yes (Double Link Standard)
U.S. Commercial Warranty		
10 yrs. (5 yrs. corrosion)	Frame	10 yrs. (5 yrs. corrosion)
2 yrs. (drive mechanism, braking system, cranks)	Mechanical parts	2 yrs. (drive mechanism, braking system, cranks)
1 year	Labor	1 year
6 mos. (saddle, pedals)	Wear Items	6 mos. (saddle, pedals)
Note Warranty terms are for the U.S. only and vary by region. Contact the distributor in your country and region.		



IC PRO



Chain Drive

IC PRO 20



Chain Drive

Technical Specs

50" L x 22.5" W x 44" H	Product Dimensions	50" L x 22.5" W x 44" H
130 lbs. (59 kg)	Product Weight	130 lbs. (59 kg)
300 lbs. (136 kg)	Max User Weight	350 lbs. (159 kg)
Zinc galvanized and powder coated	Frame Finish	Zinc galvanized and powder coated
Silver	Frame Color	Satin Black
Stainless steel	Seat Slider, Handlebars and Hardware Materials	Stainless steel plated
Chain drive using forged steel crank and ISIS oversized bottom bracket	Drive System	Chain drive using forged steel crank and ISIS oversized bottom bracket
No - fixed gear drive train (silver flywheel decal)	Smart Release	No
Typically 4'11" to 6'8" (150 to 203 cm) tall	User Compatible Size Range	Typically 4'11" to 6'8" (150 to 203 cm) tall
No	MPower™ Console Compatible	No
Yes (Double Link Standard)	Triple Link Pedal Compatible	Yes (Double Link Standard)
U.S. Commercial Warranty		
10 yrs. (5 yrs. corrosion)	Frame	10 yrs. (5 yrs. corrosion)
2 yrs. (drive mechanism, braking system, cranks)	Mechanical parts	2 yrs. (drive mechanism, braking system, cranks)
1 year	Labor	1 year
6 mos. (saddle, pedals)	Wear Items	6 mos. (saddle, pedals)
<p>Note Warranty terms are for the U.S. only and vary by region. Contact the distributor in your country and region.</p>		



THE TOOL LIST BELOW IS NEEDED TO REPAIR AND PERFORM PREVENTATIVE MAINTENANCE ON ALL SCHWINN INDOOR CYCLING BIKES.

Tool	Supplier	Part Number
Pedal Wrench	Park Tool	PW-3
Crank Arm Removal Tool	Park Tool	CCP-2, CCP-44
	Pedro's	6451210
Bottom Bracket Removal Tool	Park Tool	BBT-18
Smart Release Removal Tool	Park Tool	FR-6
3/8" Drive Ratchet	Various	
3/8" Drive Extension (3")	Various	
1/2" Drive Ratchet	Various	
Std. Length and Long Phillips Head Screwdriver	Various	
3MM T Handle Allen Head	Various	
5/32" Allen Head Socket 3/8" Drive	Various	
6MM Allen Head Socket 3/8" Drive	Various	
5/16" Allen Head Socket 3/8" Drive	Various	
8MM Allen Head Socket 3/8" Drive	Various	
14MM Socket 3/8" Drive	Various	
15MM Socket 3/8" Drive	Various	
17MM Open Ended Wrench	Various	
21MM Open Ended Wrench	Various	
26MM Socket 1/2" Drive	Various	
Adjustable Crescent Wrench (Large and Small)	Various	
Soft-jawed Channel Locks	Various	
Recommended Lubes, Cleaners, and Supplies:		
Schwinn Fit-Tech Silicone Lube	Schwinn	72016
Schwinn Equipment Polish	Schwinn	73200
Schwinn Citrus Chain Wax	Schwinn	72013
Schwinn Quick Shot	Schwinn	72012
Schwinn Foam Degreaser	Schwinn	72011
Tri-Flow / DuPont Teflon Spray	Various	
White Lithium Grease	Various	
Clean Shop Towels	Various	



Preventative Maintenance Schedule

Long-term effects and cost comparisons usually favor preventative maintenance over performing maintenance actions only when the system fails.

AC Series PM Schedule				
	Daily	Weekly	Monthly	Comments
Wipe Down all Surfaces, including seat and Handlebar assy	X			
Inspect Pedals and Crank for wear and movement	X			
Inspect all Hardware including seat, pop pins and Brake assy		X		
Tighten pedals and Crank		X		Torque Crank bolts to 40-45 lb*ft and Pedals to 25-30 lb*ft
Perform brake test to assure brake assy is working correctly		X		
Inspect condition of pedal straps		X		
Check Flywheel and Drive assy (Belt/Chain) for Alignment and Vibration issues			X	Ensure flywheel is centered
Inspect Bottom Bracket assy			X	48-50 lb*ft
Inspect and Tighten all Hardware			X	
Calibrate Computer, checking Sensors and Cables (if Applicable)			X	

IC Series PM Schedule				
	Daily	Weekly	Monthly	Comments
Check Safety & Warning Labels	X			
Spot Check Chain	X			
Inspect & Tighten Frame Screws/Bolts		X		
Inspect Brake Mechanism Alignment			X	Ensure flywheel is centered
Inspect Crank Bolts		X		Torque to 40-45 lb*ft
Inspect Pedal Bolts		X		Torque 25-30 lb*ft
Lubrication				
Chain			X	Teflon Spray
Brake Pads			X (or every 90 days)	Teflon Spray
Handlebar & Seat Posts			X	Silicone Spray
Cleaning				
Clean Console	X			Clean with a water dampened cloth & wipe dry after cleaning
Clean Frame & Covers	X			Clean with a water dampened cloth & wipe dry after cleaning



Daily
 Chaque jour
 Täglich
 Tous les jours
 Dagelijks
 Una volta al giorno
 A diario
 日常
 每天



Let dry
 Laissez sécher
 Trocknen lassen
 Faire sécher
 Laten drogen
 Lasciare asciutto
 Dejar secar
 乾いた状態を保つこと。
 保持干燥



Weekly
 Chaque semaine
 Wöchentlich
 Toutes les semaines
 Wekelijks
 Una volta alla settimana
 Cada semana
 週間
 每周



Inspect
 Inspectez
 Prüfen
 Inspecter
 Controleren
 Ispezionare
 Inspeccionar
 点検すること。
 検査



Monthly
 Chaque mois
 Monatlich
 Tous les mois
 Maandelijks
 Una volta al mese
 Al mes
 月間
 每月



Tighten
 Serrez
 Schrauben nachziehen
 Besseren
 Vastdraaien
 Serrare
 Apretar
 緩んだ部品を締め直すこと。
 拧紧部件



Clean/Wipe
 Nettoyez/essuyez
 Reinigen/Abwischen
 Nettoyer/Essuyer
 Schoonmaken/wrijven
 Pulire/asciugare
 Limpiar
 汚れを拭き取り/掃除すること。
 清洁 / 擦拭



Lubricate
 Lubrifiez
 Schmieren
 Lubrifier
 Olien
 Lubrificare
 Lubricar
 潤滑油を塗ること。
 潤滑



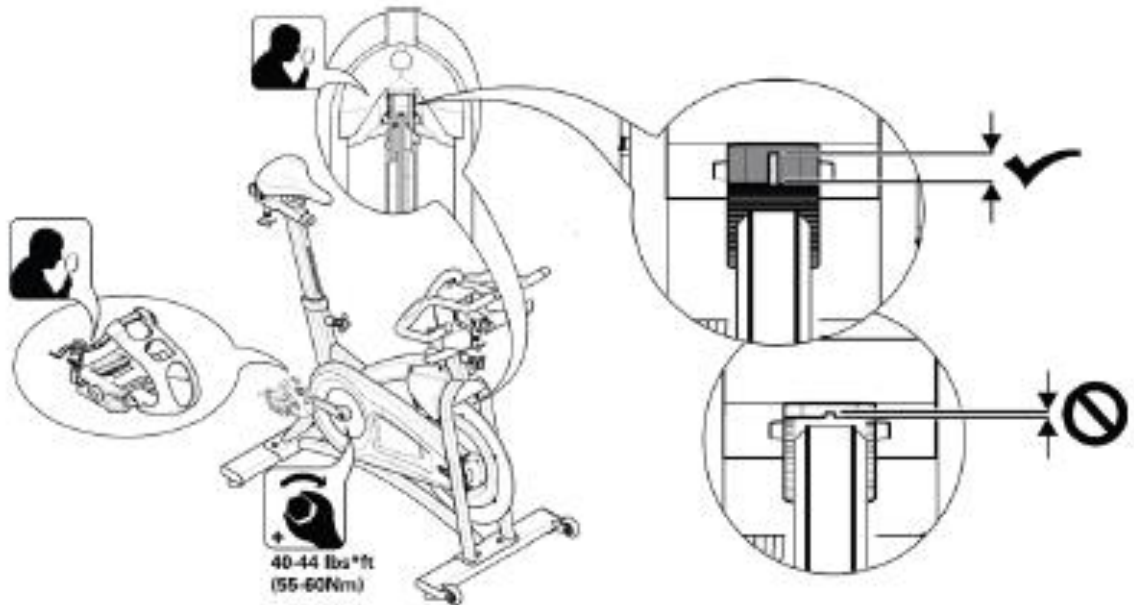



Adjustments

Belt / Chain Tensioning:

Caution: Never touch the belt / chain with a cloth or your hand while it is moving.

1. Use a 14mm wrench or socket to loosen flywheel nuts and 10mm deep socket to loosen tensioning screws so that when you grab a pedal and try and move it back and forth, you can feel play in the belt/chain.



2. Use a 10mm socket to gradually tighten the drive side tensioning screw until you are able to move the belt/chain up/down $\frac{1}{2}$ " - $\frac{3}{8}$ " (in either direction), at the tightest point.



3. Check for free play with the crank in the 12, 3, 6, and 9 o'clock positions to ensure there is no excessive play.



Chain / Belt Tensioning

4. Tighten the non-drive side tensioning screw to align and center the flywheel in the brake assembly. NOTE: Ensure the flywheel aligns with the frame.
5. Tighten both flywheel nuts.



Note: If using a tension gauge to test belt tension, the ideal range should be between 45 – 50 lbs.

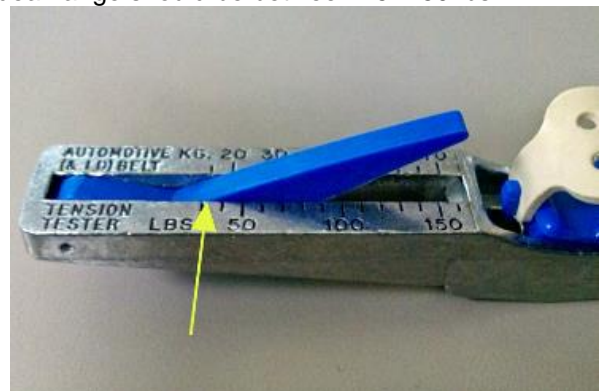

6. Over tensioning the belt / chain can cause undue stress on the flywheel and bottom bracket bearings. Test the bike for proper belt / chain tension, adjust further as needed.



Belt / Chain Removal / Replacement:

1. Remove the outer chain guard. The outer guard slides off easiest with the right pedal at 10 o'clock.
2. Use the 14-mm wrench or socket to remove each axle nut from the flywheel axle. Remove the chain tensioner bolts with a 10-mm wrench, which will allow you to take off each chain adjustment bracket.
3. Carefully lower the flywheel to the bottom of the frame. You can now take the old chain off and put the new chain on.
4. Carefully lift the flywheel back into place on the frame.
5. Reinstall each bracket to the axle and tighten each bolt evenly so the flywheel stays aligned with the frame.
6. Adjust the chain tension by locating the point where the chain is tightest during one revolution of the crank. Check the tension; you should be able to move the chain up/down a total of 3/8" (in either direction), at the tightest point.
7. Once the chain is adjusted, reattach the outside chain guard using the three 4-mm Allen head screws.
8. Ensure the chain is properly lubricated prior to testing the bike. Listen for any grinding, which could be caused by the chain tension being too tight or the flywheel being out of alignment with the frame.
9. Test the bike for proper chain tension. Make any final adjustments.



Pedal Adjustment

Schwinn recommends when the machine is used in a club or studio environment the pedals must be replaced every 1 year to maintain maximum user safety and performance. Only use replacement pedals available from Schwinn.

Schwinn pedals have threaded shafts that connect to the crank arms. The Right pedal is normal, right-hand threaded. The Left pedal is reverse threaded, meaning you turn to the Left to tighten and Right to loosen. Verify pedals are tight (25 -30 lbs.*ft) on a weekly basis. Use a 15mm / 9/16" pedal wrench to properly tighten and loosen pedals.

Ensure the pedal shafts are not cross-threaded when tightening into the crank arms.

Standard Double Link Pedal

- **Option 1:** Street shoe entrance with toe cage & strap.
- **Option 2:** SPD clip with adjustable tension spring.



Triple Link Pedal

- **Option 1:** Street shoe entrance with toe cage & strap.
- **Option 2:** SPD clip with adjustable tension spring
- **Option 3:** remove black portion of pedal for LOOK binding.





Adjusting Leveling Feet

1. Check to ensure the foot levelers on the bottom of the stabilizers are even. Adjust the levelers until bike is even and square on the floor. If present, secure the leveler nuts to prevent them from loosening

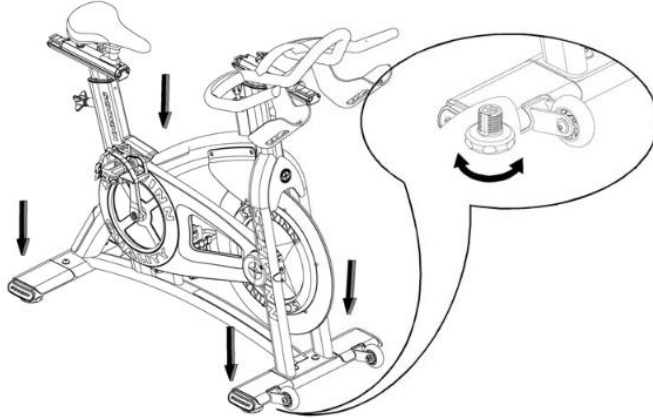

Adjusting Crank Arms and Bottom Bracket

1. Using a pedal wrench, ensure the pedals are tightly screwed into the crank arms. Tighten pedals to 25 -30 lbs.*ft.
2. Make sure the crank bolts on both crank arms are tight. Tighten and torque the crank arm bolts to 550-600 kg*cm / 40-44 lbs.*ft / 55-60 Nm
3. Make sure the bottom bracket is tight in the frame and bearings operate smoothly. Torque bottom bracket cups to 600-700 kg*cm / 44-51 lbs.*ft / 60-69Nm.



Lubricating the Handlebar and Seat Posts

1. Clean and lubricate the handlebar/seat post extension tube and frame sleeves with silicone lube. If fit remains tight, switch the handlebar or seat post with one from another bike. If this does not fix the problem order a new sleeve.





Resistance Mechanism Adjustments

AC Magnetic Resistance System

A revolutionary brake system uses magnets to create resistance. Nothing physically touches the wheel! There are no wear parts to maintain or replace over time, and the result is a silky smooth ride that is consistent both from bike to bike, and from ride to ride.

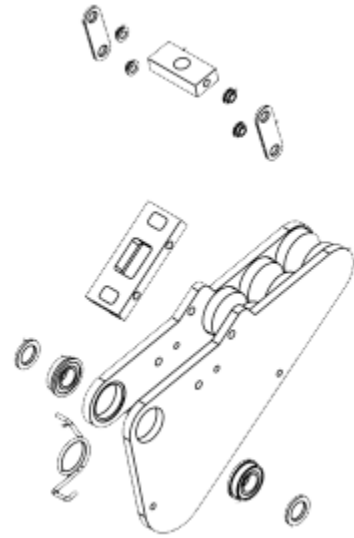

To ensure resistance consistency, especially when measuring Power using the MPower Echelon, or Echelon2 console with Power sensor, ensure the magnet gap is between 10.5mm – 11mm.

Use the zeropoint calibration tool, included with the console, to verify magnet gap.

If necessary use a pair of soft-jawed channel locks to adjust the brake carriage to ensure the gap is within this range.

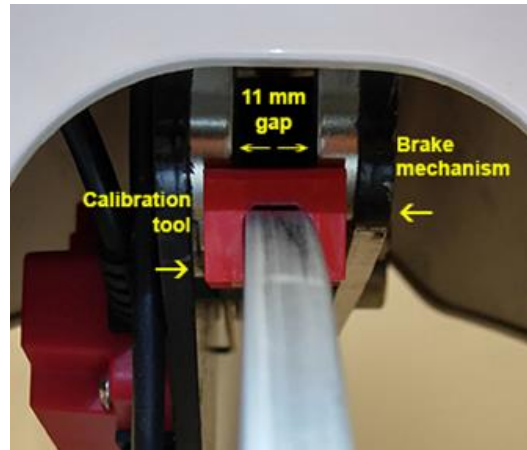

Incorrect

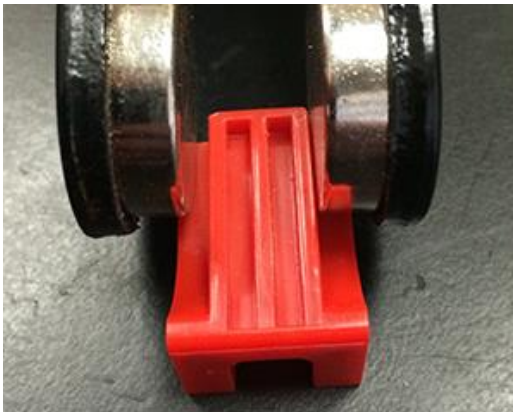

Correct

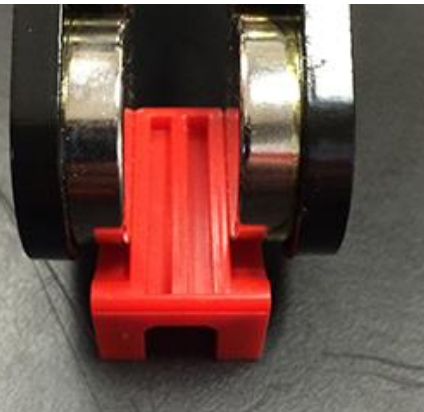



Resistance Mechanism Adjustments

IC Magnetic Resistance System

Caliper-style, felt brake pads provide proven and durable performance.

It is recommended that you set the brake pads on newspaper outside and to soak the felt pad material with Silicon or Teflon spray lubricant.

This will allow the pads to slide smoothly over the flywheel rim and avoid any "grabbing" or squeaking during use.

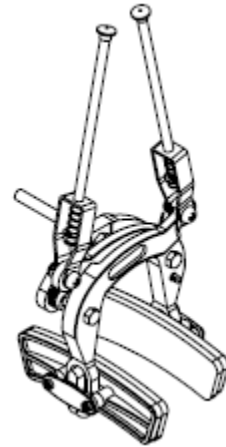

Adjust the pad so it makes contact with the flywheel.





Brake Rod and Knob Replacement

1. Loosen the Brake Adjustment Rod (A) clockwise while loosening the Brake Adjustment Housing (B) counter-clockwise.



2. As the Brake Adjustment Rod unscrews from the Link Arms (C) raise the Brake Adjustment Housing and Rod.

Note: Lubricate the Brake Adjustment Rod threads (C) upon reinstalling into the Link Arms.

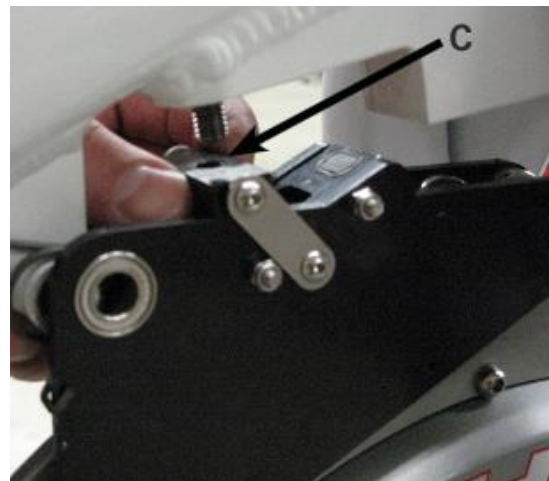

3. Remove the torsion spring and slide out the brake assembly for replacement

Note: When reinstalling the Brake Adjustment Rod into the Link Arms do not overtighten as this will bend the Link Arms





Adjusting the Smart Release™ (if applicable)

Attention: Only a mechanic trained to work on Schwinn® bicycles should do this procedure. Make adjustments to the Smart Release™ mechanism only to restore the mechanism to factory specifications. Never overtighten.

1. Begin by riding the bike. This forces the Smart Release™ mechanism to break free. Pedal up to a moderate speed with little or no resistance on the flywheel while applying enough back pressure to the cranks to release the mechanism. Repeat this several times to ensure that the mechanism is up to operating temperature and to feel the initial setting.
2. From the front of the bike, insert the Smart Release™ adjusting tool into the space between the chain guard and the flywheel.
3. Rotate the flywheel until the 7mm diameter hole in the Smart Release™ adjusting plate is visible from the front of the bike.
4. Tighten the resistance mechanism to prevent the flywheel from rotating.
5. Place a 50lb. dumbbell or weight on the right side pedal (chain guard side) with the crank in the 9 o'clock position.
6. Note: When properly adjusted, the Smart Release™ mechanism should break free allowing the crank arm to rotate down under this amount of weight.
7. Insert the Smart Release™ Adjusting Tool so that the bend in the tool corresponds to the shape of the flywheel.
8. Insert the pin of the tool into the hole of the Smart Release™ adjusting plate.
9. Pull the handle of the tool UP toward the top of the flywheel to increase the release pressure (higher breakaway force) and DOWN to decrease the release pressure (lower breakaway force).
10. Ride the bike to test that the factory specified resistance has been achieved.

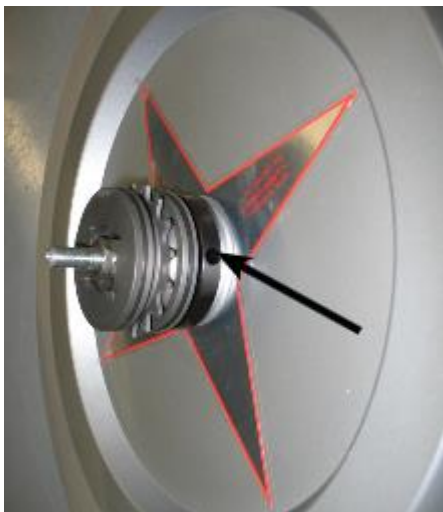

Smart Release hub location



Smart Release adjusting tool



Smart Release™ Removal / Replacement

1. With the flywheel removed, release all pressure from the SR locking ring by turning it clockwise until it bottoms out on the flywheel threads. This will reduce the torque required to move the SR mechanism.



2. Place an axle nut on the end of the axle that contacts the ground to protect the threads.



3. Place FR-6 freewheel tool on the Smart Release™ system. Keep the freewheel tool in place with one of the axle nuts.

Note: Though the picture shows the axle nut in an upright position, it fits better into the FR-6 free-wheel tool upside-down. Do not overtighten the axle nut against the FR-6 free-wheel tool.

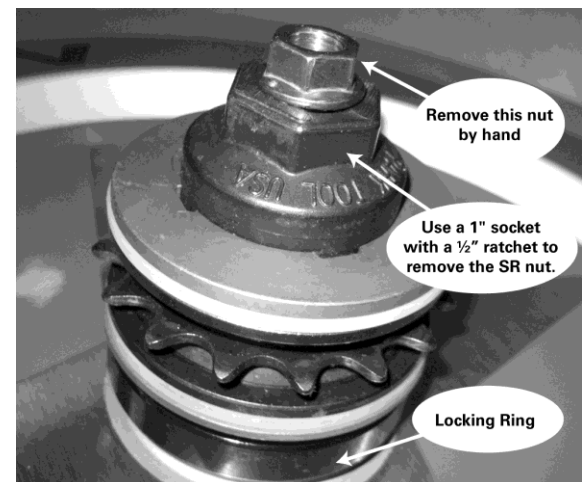



4. Place the ratchet at 9 o'clock, use one hand to stabilize the ratchet and strike in a downward direction with a medium rubber mallet. If the system cannot be "broken" loose with the rubber mallet, a large metal hammer may be needed.

Note: If the Smart Release™ assembly has never been adjusted or removed it may be difficult to loosen.

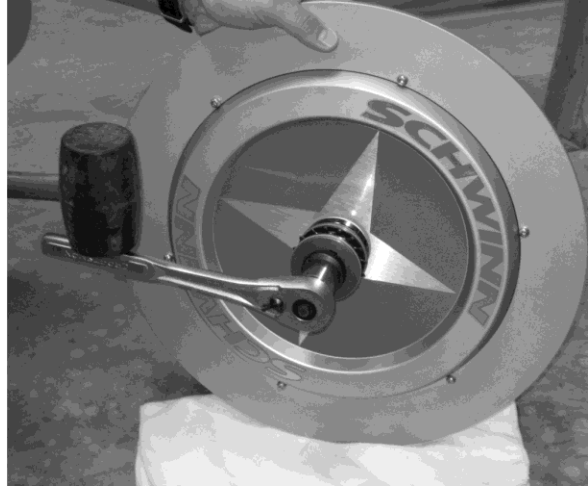

5. Use a 6-7mm Allen wrench to keep the adjustment ring flat against the face of the flywheel and separate from the SR mechanism. If the adjustment ring is allowed to turn with the clutch, it will bind together tightening the SR system.



6. Remove the Clutch from the flywheel, leaving the adjustment ring and conical washer on the flywheel.





SCHWINN

7. Remove the entire Smart Release assembly and components. During reassembly, ensure that the grooves of the interface plates are facing the nylon rings.

Note: Ensure there is no grease, oil, or any other substance on the interface plates, or nylon ring before reassembly.

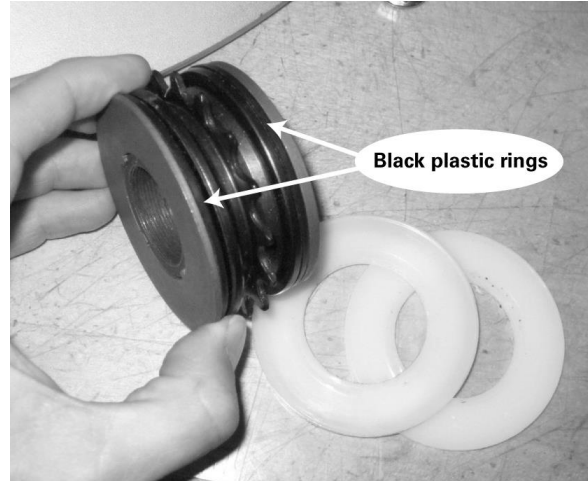

Smart Release ring orientation

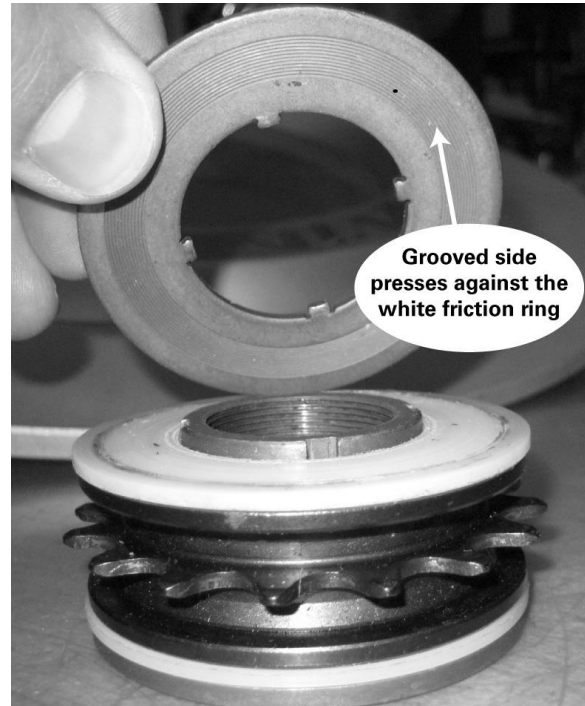

Installing the friction plates

Smart Release Reassembly

- Place the conical spring washer onto the flywheel with the flat portion of the spring washer facing the clutch assembly. Ensure that the point of the conical washer is facing the flywheel. There is a clutch assembly binder that is screwed inside the cylinder of the outer plate. When the clutch is disassembled, this mechanism sometimes turns into the cylinder. If this binder (dark metal with two slots) isn't flush with the face of the outside interface ring and you attempt to re-install the clutch, it will hang up on axle nuts before it is completely screwed into place.



NOTE: The flywheel sprocket is unidirectional. This means that there is only one correct way to put the flywheel sprocket and clutch plates together.

The best way to check that the clutch parts are in the right order is to hold the hub sprocket in one hand and place the flanged hub lock ring through the outside of the hub sprocket. Picture it as if it were on the flywheel, the outer interface plate should spin clockwise.

- Tighten by hand as far as possible, and then use the FR-6 tool and a 1" socket and large ratchet 1/2" driver to tighten the system down.
- Ensure the internal lock ring on the outside clutch plate is screwed out almost flush with the outer interface ring. If the internal lock ring is screwed into the outer interface plate it will prevent the clutch from being installed correctly and will cause the clutch to drag on the frame drop-out tabs.
- Remember to use the axle nut to hold the FR-6 tool to the system to avoid slippage. Use the mallet to strike the ratchet. The system must be very tight and locked down to avoid the possibility of loosening during use. The recommended torque foot pound (TFP) level for the clutch on the flywheel is 65-75 ft./lbs. Once the Smart Release™ is locked down completely, you are ready for reassembly of the bike.





Bottom Bracket Removal Procedure

1. Use a #2 Philips head screwdriver to remove all the inside/outside chain guard screws (Fig 1 & 2)

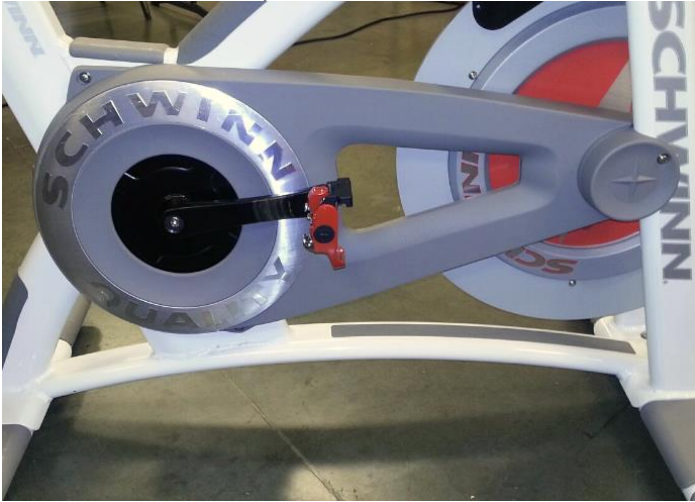

Fig. 1



Fig. 2

2. Turn the (user's) right side crank arm to approximately 8 o'clock position to remove the outside chain guard cover (Fig 3).

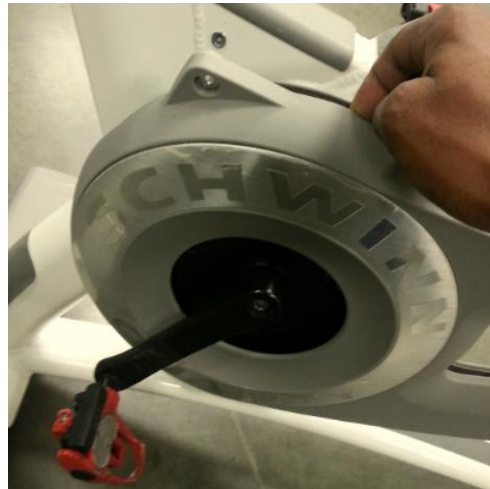

Fig. 3



Bottom Bracket Removal Procedure

3. Use the 8mm hex key to remove both the right and left side crank arm bolts (Fig 4). Remove the left and right crank arms using the crank removal tool and 15mm open end/combo wrench (Fig 5).



Fig. 4



Fig. 5

4. Using the flat head screw driver, remove the plastic locknut cover (Fig 6) on the (user's) left hand side.



Fig. 6

5. Insert the Schwinn bottom bracket tool (PN: [74465](#), BBT-18) into the left side of the bottom bracket. Use a dead blow hammer and tap on the tool to secure the teeth to the cup (Fig 7).



Fig. 7



Bottom Bracket Removal Procedure

6. Using the adjustable wrench, turn the bottom bracket tool counter-clockwise to the bottom bracket cup (Fig 8). Note: It may be necessary to use a breaker bar for extra leverage



Fig. 8

7. Once the left cup has been removed, use the flathead screwdriver to pry the bottom bracket tool off of the cup.
8. Turn the lock ring counterclockwise and remove it from the BB cup.
9. Then Insert the BBT in the user right side BB cup. Use your dead blow hammer and tap on it to secure the BBT teeth to the cup.
10. With your 1 ½" adjustable wrench, turn the BBT clockwise to loosen the BB cup. (If necessary, use a breaker bar for extra leverage.)

Note: Once you have successfully removed the bottom bracket from the frame, the threads need to be clean. It is VERY important the threads are thoroughly cleaned prior to installing the new bottom-bracket.



Preparing Bottom Bracket Threads

1. Place your bucket/drip pan next to the bottom bracket of the bike.
2. Lean the bike at an angle and spray the cutting oil solvent (simple green or comparable) on the threads (Fig 9). (allow the excess fluid to drip into the pan)



Fig. 9

3. In a clock/counterclockwise motion, use your wire brush to clean the threads on both sides of the bottom bracket housing (Fig 10).

Do not brush across the threads



Fig. 10

4. Wipe the threads clean with a clean towel and allow 10-15 minutes for the surface to dry (Fig 11).



Fig. 11



Bottom Bracket Replacement Procedure

This procedure shows the red-cupped bottom bracket. Standard bottom bracket cups are black.

1. User right or drive side of the bottom bracket has a lip, the left side is a locking sleeve shown in Fig 12.

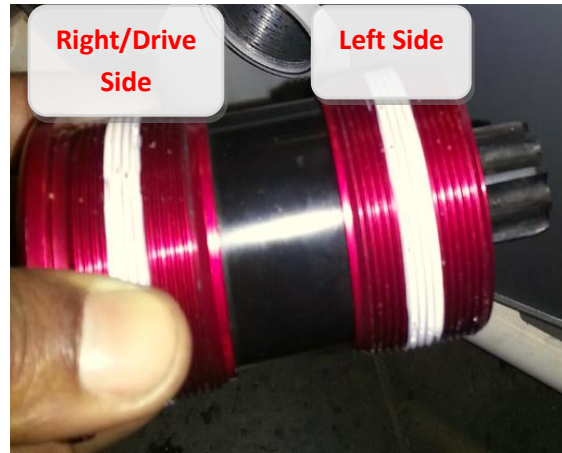

Fig. 12

2. Remove the side locking sleeve of the bottom bracket (Fig 13). Pull on it to separate it.



Fig. 13

3. On the user right of the bottom bracket, apply Loctite 242 to the bottom bracket housing. Thread the cup in the frame counterclockwise by hand (Fig 14).

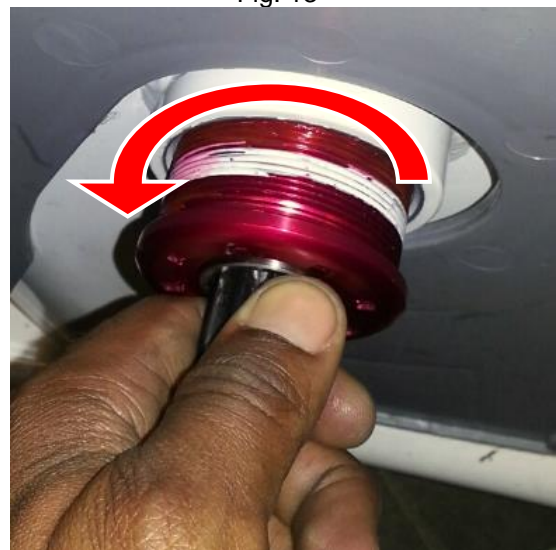

Fig. 14

Bottom Bracket Replacement Procedure



4. Insert the Schwinn bottom bracket tool (Part# 74465, BBT-18) into the BB cup. Use your dead blow hammer and tap on it to secure the BBT teeth to the cup.
5. With your 1 1/2" adjustable wrench, turn the BBT counterclockwise to tighten the bottom bracket cup (Fig 15). (Torque spec is 50 lb*ft)



Fig. 15

6. Insert the left side BB cup and start to thread (clockwise) the cup by hand.
7. Then Insert the BBT in the BB cup. Use your dead blow hammer and tap on it to secure the BBT teeth to the cup.
8. With your 1 1/2" adjustable wrench, turn the BBT clockwise to tighten the bottom bracket cup. (Torque spec is 50 lb*ft)
9. Install the lock ring threading it clockwise by hand, and use your flathead hammer to secure it (Fig 16). (Just needs to be snug)



Fig. 16

10. Install the lock ring cover, make sure has a flush fit all the way around



Bottom Bracket Replacement Procedure

11. Install the left crank arm by aligning the splines to the bottom bracket shaft; use your dead blow hammer to pull the arm as close to the inside race as possible (Fig 17).



Fig. 17

12. Then install the crank arm bolt and torque it down to 35-40 lb*ft
13. With the left crank arm in the 6 o'clock position, install the right crank arm in the 12 o'clock position. Aligning the splines to the bottom bracket shaft, use your dead blow hammer to pull the arm as close to the inside race as possible.
14. Then install the crank arm bolt and torque it down to 35-40 lb*ft
15. Wrap the chain around the top portion of the sprocket and turn the arm counterclockwise to completely install the chain (Fig 18).



Fig. 18

16. Turns the right crank arm to approximately the 8 o'clock position in order to install the outside chain guard cover.
17. Use #2 Philips head screw driver to install all of the inside/outside chain guard screws.
18. Make sure the chain/belt tension and flywheel alignment are correct and test bike. Make adjustments as needed.



Flywheel Bearing Removal / Replacement

As of serial number 100176DAY11270248 (July 4, 2011) and forward, all bikes contain a double bearing design.

1. Remove flywheel from the bike frame.
2. Remove two M10-1.0 nuts that hold the flywheel bearings into the flywheel hub.
3. Remove spacers.
4. Remove and replace bearings.
5. Replace the spacers on the axle to their previous location.
6. Replace two M10-1.0 nuts on either side of the axle.
7. Replace flywheel onto the bike frame.
8. Rotate flywheel to verify new bearings are working properly.

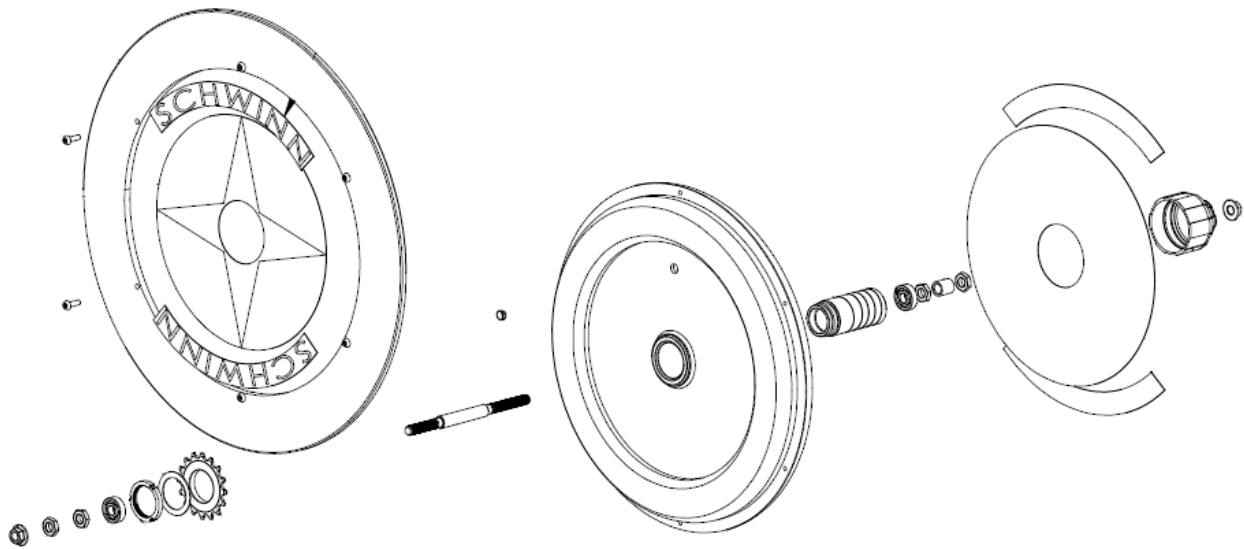



SCHWINN

CORPORATE HEADQUARTERS

Core Health & Fitness

4400 NE 77th Avenue, Suite 300

Vancouver, WA 98662

(888) 678-2476

For further support on Schwinn products, please visit:

<http://support.schwinnequipment.com>